

CONVECTAIR

PICCOLO

7831



Installation & Operating Instructions

421AA2357 Incl.A

ATTENTION : Documents to be kept by end-user

INTRODUCTION :

Dear owner,

- Congratulations on the purchase of this premium electric heater. CONVECTAIR develops and produces the highest quality heating product in the electrical industry.

- To obtain the best results and the ultimate in performance and comfort, please take a moment to read the installation , operation and maintenance instructions detailed in this manual

TABLE OF CONTENTS

QUICK START GUIDE	Page 3
1- SPECIFICATIONS.....	Page 4
2- RECOMMENDED SET-UP.....	Page 4
3- INSTALLATION AND MOUNTING.....	Page 5
4- ELECTRICAL CONNECTION.....	Page 7
5- OPERATING INSTRUCTIONS.....	Page 9
6- OVERHEAT CONTROL.....	Page 10
7- MAINTENANCE.	Page 10
8- TROUBLESHOOTING	Page 11
9- IDENTIFICATION OF YOUR HEATER	Page 11
10- WARRANTY INFORMATION	Page 11

WARNING :

Your heater is already equipped with a precise electronic thermostat. It must not be connected to a wall thermostat.

- QUICK START GUIDE -

On/Off indicator

On/Off switch

Thermostat adjustment

Accelerated heat ventilation button (30 minutes)

Accelerated heat ventilation indicator

Comfort zone

Heating indicator

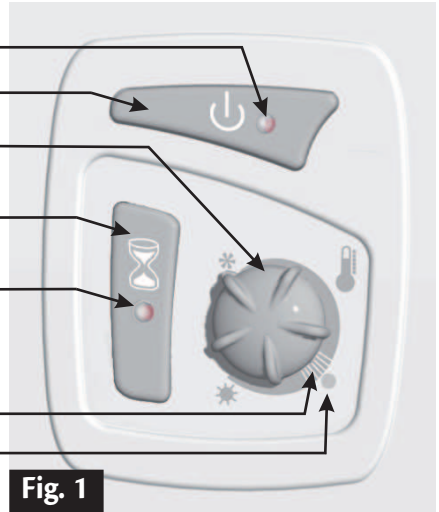

Electrical requirements : 240 V

See pages 6 and 7.

Installing and connecting the heater

See pages 5, 6 and 7.

To turn the heater ON or OFF

Press the  switch briefly

To set the temperature

Set the temperature dial at the comfort zone. Wait for the temperature to stabilize. Adjust up or down for the required comfort level (see page 8).

Fast heat

With the heater ON, press the  button.

Trouble shooting page 10

To contact Convectair : see page 10

1 SPECIFICATIONS

- Your new PICCOLO is a fan heater partially enclosed.
- This heater is equipped with 2 fan forced heat levels : 750W regulated with the electronic thermostat and 1500W accelerated heat on demand for 30 minutes.
- Minimum obstruction and designed to heat your room quietly, constant heat, it is a perfect heater for your bathroom or other intermittent rooms.
- Your PICCOLO can be used with the optional **CONVECTAIR** Programmer Module (pilot wire) allowing scheduled temperature set-backs in periods of prolonged absence providing the same comfort and more savings.

READ CAREFULLY ::

These instructions are essential to install and use your new PICCOLO safely.

Model#	Volts, cycles	Capacity	Height (facade)	Width (facade)	Depth (facade)	Height (built-in)	Width (built-in)	Depth (built-in)	Weight
7831 - C15	240V 60 Hz	750 W / 1500 W	40 cm (16 in.)	38 cm (15 in.)	2.5 cm (1 in.)	37 cm (14 ^{1/2} in.)	31 cm (12 in.)	8.5 cm (3 ^{3/8} in.)	5.7 Kg (12.6 lb)

2 RECOMMENDED SET-UP

- Your heater must be installed in accordance with national and local codes and CONVECTAIR recommends an installation by a qualified electrician.
- Your heater must be installed so that the control panel is out of reach from anyone in the bath-tub or in the shower. Do not install over a bath-tub or spa.
- Do not install the heater behind a door, furniture or others obstacles, or in front of an airexhaustvent. Keep combustible materials such as curtains, away from the heater.
- Your heater is equipped with a heating element that may reach high temperatures. Do not install or operate in the presence of gasoline, paint solvents or other flammable products.
- Maintain the minimum required clearances (height from floor, distances from side walls or furniture, drapes, etc).

3 INSTALLATION AND MOUNTING

- Identify where you want to install the heater, providing sufficient clearance around the unit (Fig.2).

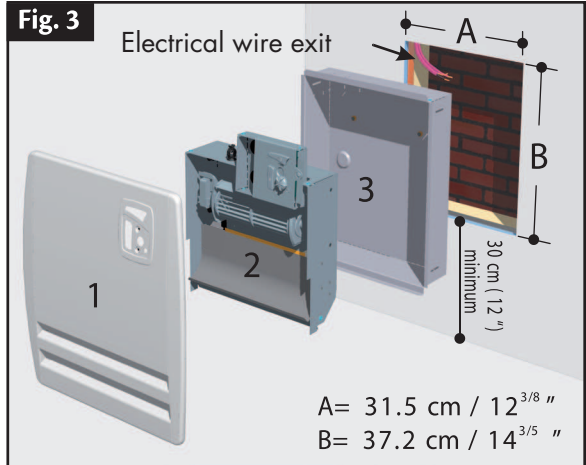
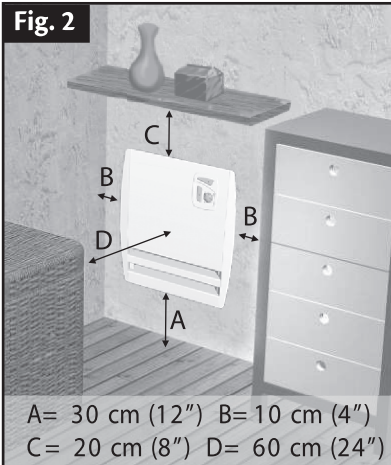

- The PICCOLO heater is partially enclosed and clearance restrictions must be respected (Fig. 2).

The heater should be installed no lower than 30 cm (12 in.) from the floor. Leave a minimum clearance of 10 cm (4 in.) on each side of the heater, 20 cm (8 in.) and 60 cm (24 in.) in front for a proper air circulation.

- Clear a rectangular opening of 37.2 cm (14^{3/5} in.) high, 31.5 cm (12^{3/8} in.) wide and 8,5 cm (3^{3/8} in.) deep between the dreams of the wall (Fig. 3).

- Make sure that the electrical wires (and the pilot wire if needed) come out of the top left corner of the wall opening (Fig.3).

- The heater can be dismantled in 3 pieces (Fig.3) : the front facade (1), the ventilation block and panel controls (2) and the built-in (3).

To dismantle the heater :

- Take off the facade by removing the 2 screws located on the panel control and the 2 screws located at the bottom of the facade (Fig. 4).

- Take off the ventilation block by removing the 2 screws (Fig. 5, A) and slide the ventilation block to click the hooks (Fig. 5, B).

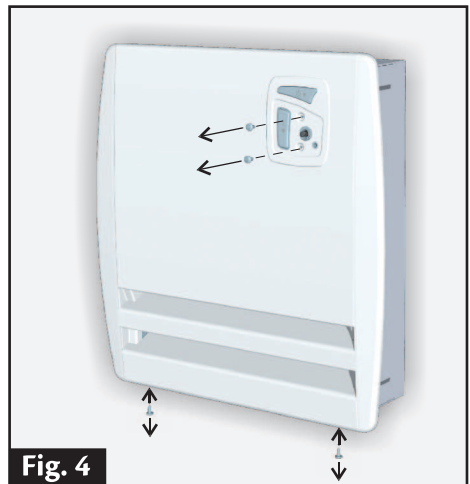

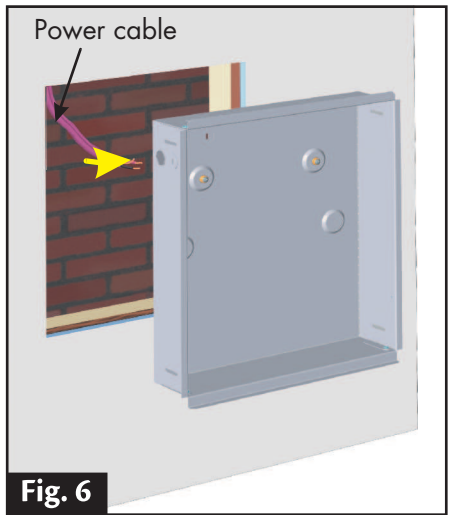
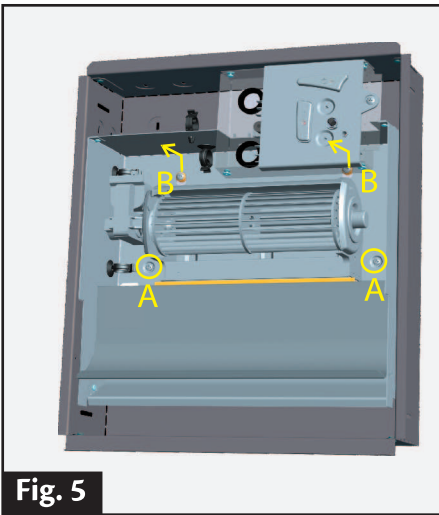

- Before placing the inner junction box inside the wall opening, remove the knock out and pass the electrical wires (Fig.6), and the pilot wire if needed, using an appropriate bushing (not include).

- Insert the inner box and secure it to the wall having taken into account the reassembly of the facade. Indeed, leave approximately 3 mm (1/8") between the wall and the upper fold of the inner box to facilitate the assembly of the facade (see Fig. 7a et 7b).

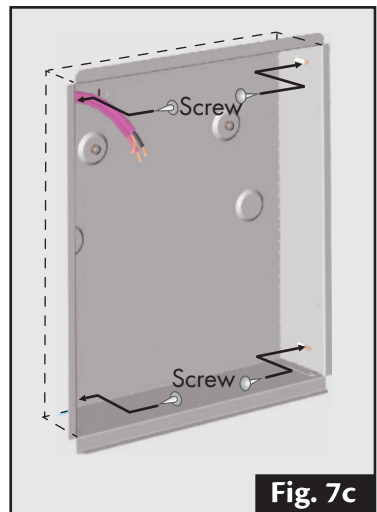
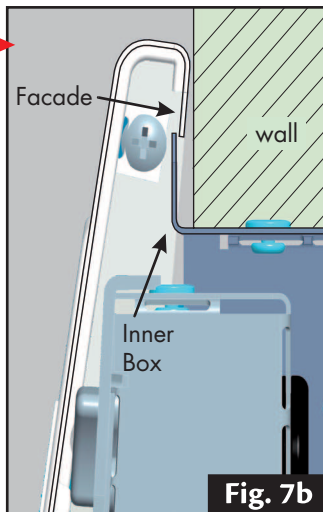
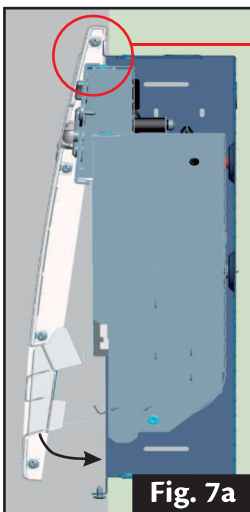

- Insert and hook the ventilation block and the protocol panel inside the inner box. Secure the ventilation box with 2 screws (Fig.5).
- Connect the electrical wires (see chapter 4 - connexion, page 7).
- When remounting the front facade, please make sure that the low small strip of the facade (Rep.A) amounts down of the deflector of ventilation block (Rep.B), and this to guarantee optimal performances.

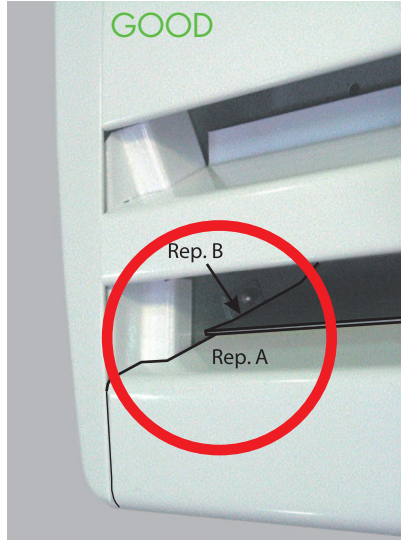
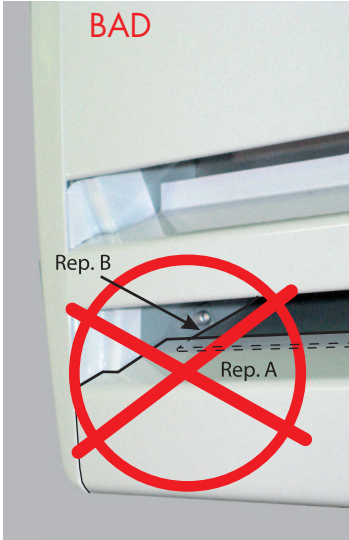

- Place and hook the facade using the inner box crease. Secure the control panel using 2 screws and then secure the facade with 2 screws (Fig.4).

WARNING : Do not pinch wires when closing the facade.

- Afix the control panel sticker provided in the bag (Fig.8) and put the control wheel in place.

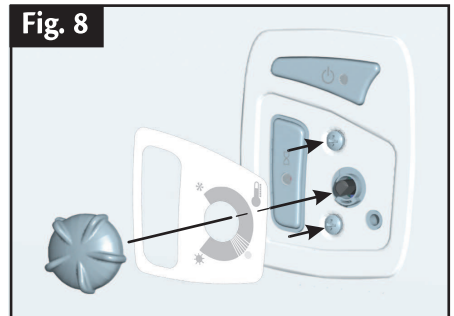

4 ELECTRICAL CONNEXION

- **CONVECTAIR recommends that your heater be installed by a qualified electrician and in accordance with national and local codes.**

- To prevent short circuits and electrical shocks turn the power off at the main panel before attempting the installation or making any repairs.



- If the power cable is damaged it must be replaced by the manufacturer, an approved service depot or a technician with similar qualifications to avoid any danger.

- The connection of the heater must be done inside the inner box on the left side of the control panel. Connect the wires using the wire connectors provided in the bag (Fig.9).

CAUTION :

This heater must be connected to a 240 Volt (60 cycles) circuit.

- Disconnect the power supply before making wiring connections to prevent electrical shock and equipment damage. If you are using a programmer system, make sur to cut the power off ALL electrical heating circuits in the home (for more information, see the CONVECTAIR model 7392 installation notice).

RESPECT WIRE COLOR WIRING

WITH the use of pilot wire (PW)

WITHOUT the use of pilot wire (PW)

CANADA

U.S.A

CANADA

U S A

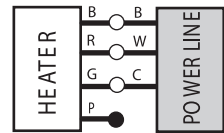
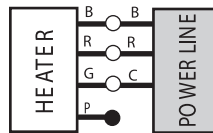
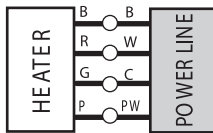
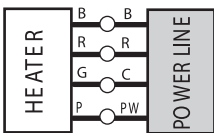

P = PURPLE R = RED B = BLACK G = GREEN C = COPPER W = WHITE PW : PILOTE WIRE

- You must connect the ground wire of the heater (Green / Yellow) with the copper wire.

- The purple wire with the seal at the extremity should not be used for the electrical connexion.

- The purple wire is used only if the heater is connected with the CONVECTAIR central programming system.

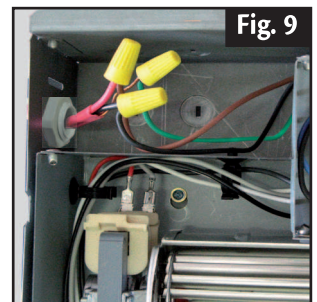
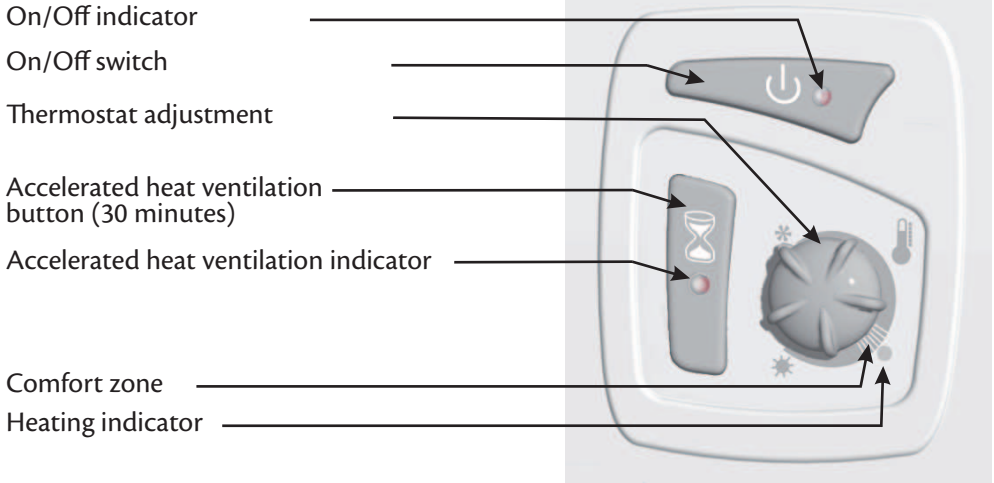

Fig. 9

5 OPERATING INSTRUCTIONS



The electronic controls have been designed to achieve maximum savings.

- Once the heater is on, set the temperature dial at the comfort zone.
- Close the doors and windows the room where the heater is located. Let the temperature stabilize for an hour.
- If the temperature is not quite right, adjust the thermostat dial up or down by half a mark.
- Let the temperature stabilize for another hour before checking again and repeat if necessary (with a quarter adjustment this time).
- Once the thermostat is set at the desired comfort setting, do not touch the thermostat dial. To turn the heater off, use the On/Off switch. To briefly raise the temperature, use the accelerated heat ventilation button.

Accelerated heat

When activating the accelerated heat, the Piccolo provides temporarily 1500W, allowing to warm more quickly the room.

- When the heater on, press the accelerated heat ventilation button to obtain 1500W for a 30 minutes duration. The accelerated heat ventilation indicator turns on.
- To revert to standard operating mode, press the accelerated heat ventilation button.
- When the accelerated heat ventilation cycle is finished, the heater resumes normal heating mode (750W).

6 OVERHEAT CONTROL

- This heater is equipped with overheat controls. In case of a malfunction of the unit (blocked air output or intake, for example) the heater will stop heating automatically. After correcting the malfunction the heater can be reset.

To restart the heater:

- Turn the heater off and turn its power supply off. Check that the front outlets are free of obstruction. Wait 5 minutes and turn the heater back on.

If no heat is generated, call your electrician or the nearest **CONVECTAIR** repair center.

7 MAINTENANCE

- To keep your CONVECTAIR unit clean, regular maintenance is suggested. To remove dust, use a soft cloth. To remove a stain, use a damp cloth. For a better performance and maximum efficiency, it is suggested that dust and lint be regularly removed from the protective grill situated at the back of your PICCOLO.

NEVER USE ABRASIVE OR ACETONE-BASED PRODUCTS TO CLEAN YOUR HEATER AS THIS MAY DETERIORATE THE EPOXY FINISH.

Operating and maintenance tips

Your **CONVECTAIR** heater will become hot when in use. Caution is advised when young children are present.

Do not insert small objects in the heater : this could cause an electrical short circuit, fire or damage to the inner components.

Any use or modifications not approved by CONVECTAIR may cause electrical short circuits, fire or injuries to the users.

In certain cases, it is possible for yellowing of the surface to occur over time. This is not due to a manufacturing defect. This is caused by surrounding air, which may contain smoke or dust, being heated and circulated through the heater.

Prevention : it is suggested that surfaces be frequently cleaned especially with units installed in locations where cigarette smoke is present or in the kitchen. Never use this heater during construction work or other activities that generate a lot of dust.

ANY REPAIR ON YOUR CONVECTAIR HEATER SHOULD ONLY BE DONE BY A QUALIFIED TECHNICIAN, AND ONLY AFTER HEATER HAS BEEN DISCONNECTED.

8 TROUBLESHOOTING

Before calling your electrician, please go through these simple checks :

- 1- Make sure the breaker in the distribution panel is in the « ON » position.
- 2- Check that the On/Off switch is on.
- 3- Activate the accelerated heat ventilation.
- 4- If no heat is emitted, check the overheat protection (see section 6, p.9)
- 5- If the light is still off, and no heat is generated, call your electrician or the nearest CONVECTAIR repair center.

9 IDENTIFICATION OF YOUR HEATER

IMPORTANT : Product information appears on the heater's identification label.

The identification label is located on the inside of the heater (visible through the superior opening of the facade).

It includes :

- The complete model number and its production reference number (A) that must be included in any warranty claim.
- Capacity (B).
- Standard certification (C).

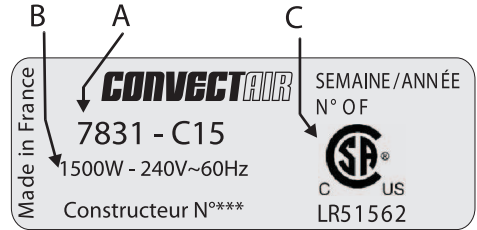

10 WARRANTY INFORMATION

2 years against all defects / 5 years on heating element.

All **CONVECTAIR** heaters are subjects to a double warranty : 2 years on all parts and manufacturing defects and 5 years on the heating element itself.

Warranty is applicable from date of purchase by the customer and under certain specific conditions. All details furnished with each heater. Please keep your invoices (purchase and/or installation).

REPAIR CENTER :

Contact **CONVECTAIR** to find closest repair center.

- Toll-free : **1-800-463-6478**
- Website : www.convectair.ca

CONVECTAIR

30, Carré Sicard, Sainte Thérèse, Qc, CANADA J7E 3X6

Tél. : (450) 433-5701 Fax : (450) 434-3166

Courrier électronique : support@convectair.ca

www.convectair.com