

# OPÉRA B

RADIANT TOWEL WARMER

## INSTALLATION AND USER GUIDE

Installation and Warranty Card  
To be read and retained by the user.

**CONVECTAIR**

421AA4940 A00



# MESSAGE FROM THE MANUFACTURER

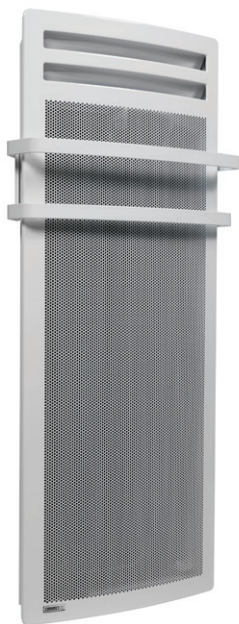

Dear user,

Thank you for your trust and congratulations on the purchase of your new **CONVECTAIR** electric heater.

We design and manufacture the highest quality devices in the electrical industry.

For the ultimate in comfort, and for maximum performance from your devices, please read the installation and operating instructions included in this manual.

Thank you.

## **CONVECTAIR**

**WARNING:** Your heater is already equipped with a precise electronic thermostat. **IT MUST NOT BE CONNECTED TO A WALL THERMOSTAT.**

# COMPATIBILITY

SMART ENERGY MANAGEMENT



## Muller Intuitiv

WITH

## Netatmo

The smart technology that electric heating lacked.

Your Opera B device is compatible with the *Muller Intuitiv* technology that uses the detection sensor of compatible Convectair heaters to understand your lifestyle and to suggest concrete and appropriate measures to save energy.



### Compatibility with voice assistants.

Download the *Muller Intuitiv with Netatmo* application on your smartphone, insert the module (sold separately) into the compartment provided at the back of compatible electric heaters and use voice control via *Apple Home Kit*, *Alexa* and *Google Assistant*.



### Keep an eye on your energy consumption.

By tracking down even the smallest unnecessary energy expenditure in your home, Convectair devices with Muller Intuitiv smart technology will help you save energy.



### Smart and optimized home.

Maximize your savings with precise room-by-room temperature control, smart planning of heating using temperature settings and customized alerts.

# 1. SAFETY

MEASURES TO BE TAKEN

Please read carefully the whole installation and operating instructions and in particular the following.



## CAUTION, HOT SURFACE

ATTENTION: Some parts of the appliance may become hot and cause light burns. A very close attention has to be taken if children or vulnerable persons are present.

1. This appliance is not intended for use by persons (including children) with reduced physical, sensory or mental capabilities, or lack of experience and knowledge, unless they have been given supervision or instruction concerning use of the appliance by a person responsible for their safety.
2. Children under the age of three should be kept away from the appliance, unless they are continuously supervised.
3. Children from three to eight years old should neither play, nor plug, nor set, nor clean, nor maintain the appliance.
4. If the appliance is covered, there is a risk of overheating. The logo reminds this risk.
5. Do not cover or obstruct the air inlet or outlet as this could cause overheating and damage the appliance.
6. Do not insert anything in the appliance.
7. This appliance has to be connected by a qualified personnel. Turn off the breaker associated to the unit before connecting or repair.
8. Installation and electrical connections must be in accordance with the national and local codes.
9. The electrical current should be protected by a residual current device in the case of an installation in a bathroom with a bathtub, shower or sink.
10. The heater must not be installed below an electrical socket.
11. This heating device is designed to provide ambient heat for new or existing residential or commercial type building.
12. Do not install the heater in a zone with air currents capable of disrupting its regulation.



**IMPORTANT:  
DO NOT COVER  
THE HEATER**

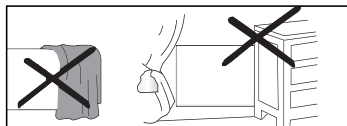

13. Minimum installation distances to the floor, walls, furniture, etc., must be respected. (Fig. A). If the device is installed in a bathroom or powder room (Fig. A2), it must be installed outside of volume 2 at a minimum distance of 0.5 m from the bathtub and/or shower and must be fitted with a class A differential circuit breaker. (IMPORTANT: See applicable national and local codes).

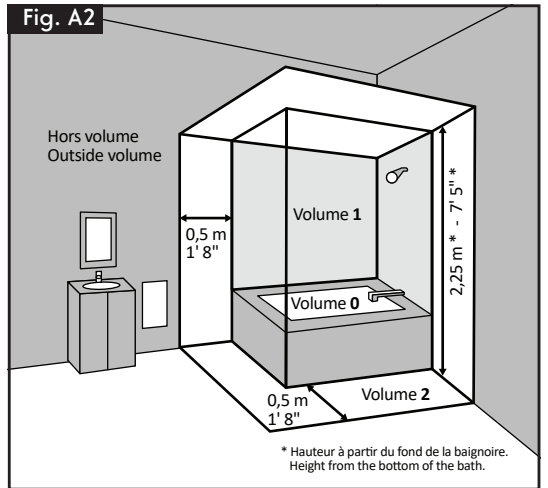
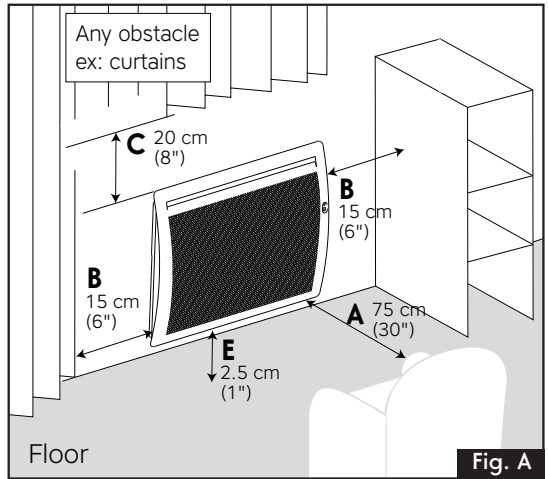

Minimum clearances	In front (A)	Sides (B)	Above (C)	Underneath (E)	Recommended height
7635-C10-BB	75 cm (30 in)	15 cm (6 in)	20 cm (8 in)	2.5 cm (1 in)	25 cm (10 in)
7635-C15-BB	75 cm (30 in)	15 cm (6 in)	20 cm (8 in)	2.5 cm (1 in)	25 cm (10 in)

**CAUTION: PLEASE MAINTAIN THE MINIMUM REQUIRED CLEARANCES (Fig. A). CONVECTAIR RECOMMENDS AN INSTALLATION HEIGHT OF 25 CM (10").**

**HEATER INSTALLATION:** This heater must be installed in accordance with national and local codes and CONVECTAIR recommends an installation by a qualified electrician.

*These instructions have been established at the moment of the heater's manufacturing and in conformity with the standardization at that moment.*

# 2. INSTALLATION AND MOUNTING

MEASURES TO BE TAKEN

The installation must comply with applicable national and local standards, and **CONVECTAIR** recommends that it be done by a certified electrician.

This manual was prepared at the time of manufacture of the device and in accordance with the standards applicable at the time.

The company reserves the right to modify at any time the Installation and User Guide to account for standards and their evolution.

- To avoid short circuits, please turn off the power at the electrical panel prior to installation or repair.
- If the power cable is damaged, it must be replaced by the manufacturer, its after-sales service personnel or a similarly qualified person to avoid any danger.
- If the device has a glass front, do not use if the glass front is damaged.

To install your heater at 25 cm (10 in) from the ground (recommended height by CONVECTAIR), follow these directions:

- 1- Free mounting brackets by pressing and pulling both locking tabs on the back of the heater (Fig. B).
- 2- Place the center of the mounting bracket's bottom holes (no. 2 Fig. B2) at the measure C (see Fig. B) from the ground and make a mark.
- 3- Check horizontality of the mounting bracket, then mark the two top holes and pierce the 4 holes for fastening.
- 4- Replace mounting bracket and fasten it appropriately with screws (not included).

Capacity	Hole spacing cm / (in)	A cm / (in)	B cm / (in)	C cm / (in)	D cm / (in)
<b>1000 W</b>	24.8 (9-3/4)	11.6 (4-5/8)	46.8 (18-3/8)	32.7 (12-7/8)	11.6 (4-5/8)
<b>1500 W</b>	24.8 (9-3/4)	11.6 (4-5/8)	46.8 (18-3/8)	38.7 (15-1/4)	11.6 (4-5/8)

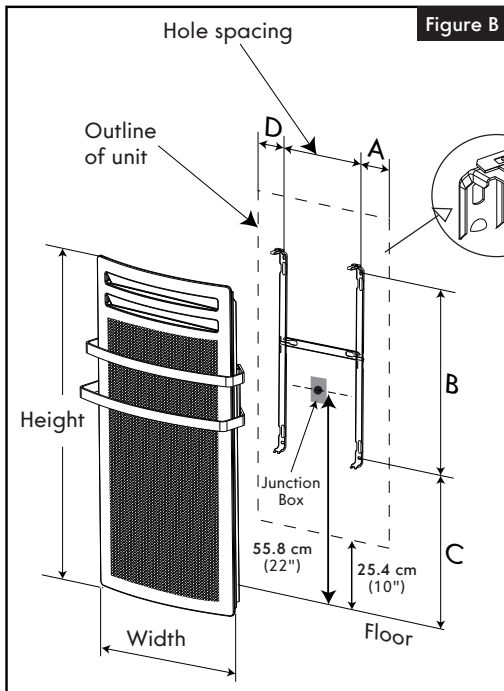

## Installation of towel rails

- 1 Bottom rail to be inserted over the unit's top (preassembled screws).
- 2 Top rail to be inserted over the unit's top (preassembled screws).

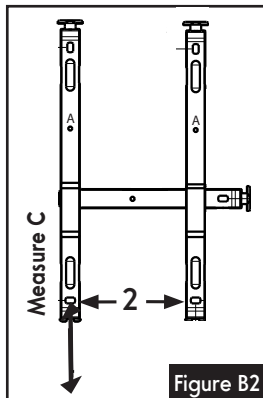
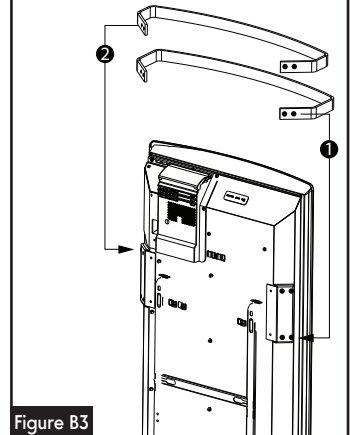

**Please read carefully the whole installation and operating instructions before connecting the heater.**

# 3. CONNECTION

MEASURES TO BE TAKEN

CONVECTAIR recommends that your heater be installed by a qualified electrician and in accordance with national and local codes.

This heater must be connected to a 240 Volt (60 cycles) circuit and with an appropriate breaker. Cut all electrical current before connecting the heater to avoid shocks and damages to the unit.

The first time your Convectair heats, a light smoke could be released due to the burning of production residues. This is normal and should disappear after 2 to 3 minutes.

**WARNING:** To prevent short circuits and electrical shocks turn the power off at the main panel before attempting the installation or making any repairs. This programmer system is old technology and will not work on this new generation.

- You must connect the ground wire of the heater (green wire) with the copper wire.
- Connect the power cables to the red and black cables.
- Never connect the pilot-wire (purple wire) to the electrical supply nor ground it.
- The purple wire with the seal at the extremity should not be used for the electrical connection. It is used only if the heater is connected with other CONVECTAIR units for synchronisation of heating schedule and temperatures.
- Fix the unit on the wall bracket before turning the power back on.

**CANADA**  
WITH the use pilot wire (PW)

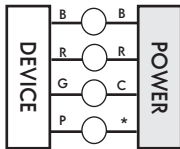

B - Black  
G - Green  
R - Red  
C - Copper  
P (PW) - Purple

\* 3/12 wire  
or FAS  
105 18/2  
300 volts  
approved.

**CANADA**  
WITHOUT the use pilot wire (PW)

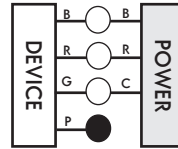

B - Black  
G - Green  
R - Red  
C - Copper  
P (PW) - Purple



# 4. QUICK START

MEASURES TO BE TAKEN



ACTIONS	PRESS	DISPLAY
Switch the heating on or off.		
Set the temperature.		
<b>Modes</b>		
To switch from one mode to another.		
<b>Comfort mode</b> To adjust to the desired set point.		
<b>Economy mode</b> Recommended for absences of less than 24 hr.		
<b>Frost protection mode</b> Recommended for absences more than 24 hr.		
<b>"Open window"</b> To enable or disable the function.		

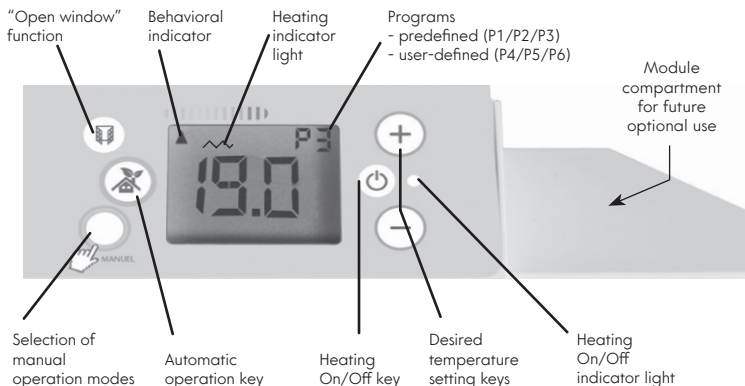

# 5. OPERATION

MEASURES TO BE TAKEN



**Be sure to remove the protective film from the display.**

## 5.1 SWITCHING ON AND OFF

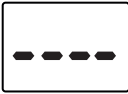
PRESS	ACTIONS	DISPLAY
	<b>Switching on.</b> The green indicator lights up and the screen displays	
	<b>Switching off.</b> The orange indicator lights up and the screen displays	

This indicator shows that your device is heating up. When the desired temperature has stabilized, it lights up and turns off based on heating needs.



### NOTE

The device stores the settings in the memory, even in the case of a power outage.

## 5.2 COMFORT TEMPERATURE SETTING

PRESS

ACTIONS

DISPLAY



Increase or decrease the desired temperature set point.



Press for **3 seconds** to store your favorite set point temperature.



To adjust the temperature to your ideal comfort level, let the temperature stabilize for a few hours, with doors closed.



### NOTE

During the temperature setting, an indicator allows you to control but also adjust the desired temperature based on its impact on consumption.

This setting is available in COMFORT mode (manual or automatic).

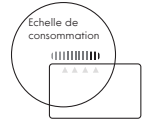

## 5.3 ECONOMY MODE ("ECO")

PRESS

ACTIONS

DISPLAY



Press **successively** to access the "ECO" mode. The screen displays:



**Briefly and simultaneously press** to visualize the "ECO" set point.



Press for **3 seconds** and the "ECO" temperature flashes to enable the user to change it.



Press for **3 seconds** to save the temperature.

### NOTE

In the event of a short-term absence (less than 24 hr), use of this operating mode is recommended for maximum savings. It lowers the room temperature by approximately 3.5°C relative to the COMFORT temperature.

The ECO set point cannot be set at a temperature greater than 19°C.



#### 5.4 FROST PROTECTION MODE

PRESS	ACTIONS	DISPLAY
-------	---------	---------



**Press successively** to access the "FREEZE PROTECTION" mode. The screen displays:



#### NOTE

In the event of a long-term absence (more than 24 hr), use of this mode is recommended for maximum savings. It helps maintain the temperature of the room above freezing (approximately 7°C).

#### 5.5 AUTOMATIC OPERATION

PRESS	ACTIONS	DISPLAY
-------	---------	---------



**Press for 3 seconds** to save your preferred settings.

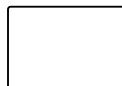





**Press briefly** for automatic operation based on your heating plan (programming of Comfort and Eco temperature ranges) and your setting preferences (preferred set point temperature, Window function, etc.).



#### NOTE

By default, the stored setting is: Preferred set temperature 19 °C, Open window function enabled.

## 5.6 MANUAL OPERATION

PRESS	ACTIONS	DISPLAY
	All automatic functions are disabled (programming) and the device switches to either:	
	<ul style="list-style-type: none"><li>• <b>Comfort mode</b> and you can adjust the set point temperature as you wish.</li></ul>	
	<ul style="list-style-type: none"><li>• <b>Eco mode</b> (this operating mode is recommended during absences of less than 24 hr).</li></ul>	
	<ul style="list-style-type: none"><li>• <b>Frost protection mode</b> (this operating mode is recommended during absences of more than 24 hr).</li></ul>	

## 5.7 ABSENCE DETECTION / ENABLING











PRESS	ACTIONS	DISPLAY
	The function is automatically enabled in automatic mode. It can be disabled (see the following table).	

### NOTE

In the event of a prolonged absence, the device progressively lowers the set point temperature. When it detects a presence, it reacts and returns to the operating mode defined by the user.



## 5.7 ABSENCE DETECTION (CONTINUED) CHOICE OF OPTIONS



PRESS	ACTIONS	DISPLAY
	First, the device must be turned off.	
 	Simultaneously press and hold until detection options 1, 2 or OFF are displayed.	
 	Allows you to switch from one option to another.	
	<p><b>Option 1 Prioritizes savings</b> See the explanation on the following page.</p> <p><b>Option 2 Prioritizes comfort</b> See the explanation on the following page.</p> <p><b>OFF Option</b> The absence detection function is disabled.</p>	  
	<b>Press for 3 seconds</b> to save your selection. The screen displays:	

### NOTE



In the event of a prolonged absence, the device progressively lowers the set point temperature. When it detects a presence, it reacts and returns to the operating mode defined by the user.

## 5.7 ABSENCE DETECTION (CONTINUED) EXPLANATION OF OPTIONS

### OPTION 1 – PRIORITIZES COMFORT

DETECTION	PILOT WIRE ORDER	RESULT
 <b>absence</b>	COMFORT	Gradual transition in ECO (90 min)
	ECO	ECO mode
 <b>movement</b>	COMFORT	Immediate transition in Comfort
	ECO	ECO mode

### OPTION 2 – PRIORITIZES COMFORT

DETECTION	PILOT WIRE ORDER	RESULT
 <b>absence</b>	COMFORT	Gradual transition in ECO (90 min)
	ECO	ECO mode
 <b>movement</b>	COMFORT	Gradual transition in ECO (90 min)
	ECO	Immediate transition in Comfort

#### NOTE

Gradual transition in ECO: In the event of a prolonged absence, the temperature set point of the device decreases progressively in 30 min steps to CF-1 then CF-2, until ECO is displayed.



## 5.8 OPEN WINDOW DETECTION FUNCTION

PRESS	ACTIONS	DISPLAY
-------	---------	---------



**Enable the function.**  
Press and hold until the window icon is displayed on the screen.



The window icon and the green indicator flash when the device turns off following a detection event.



Following an interruption, press again to restart the device.



**Disable the function.**  
Press and hold until the window icon disappears from the screen.

### NOTE

This function automatically turns off the heater in the event of a sharp fall in room temperature (e.g., an open window or door).

## 5.9 SIMPLE PARENTAL LOCK

PRESS	ACTIONS	DISPLAY
-------	---------	---------



**Lock the keypad.**  
Simultaneously press and hold for 3 seconds.



**Unlock the keypad.**  
Simultaneously press and hold for 3 seconds.



### NOTE

This function enables you to block access to device settings to prevent any inopportune modification. The heating On/Off key remains active, even when the parental lock is enabled.



## 5.9 PARENTAL LOCK WITH CODE

### SEQUENCE FOR LOCKING WITH YOUR PERSONAL CODE

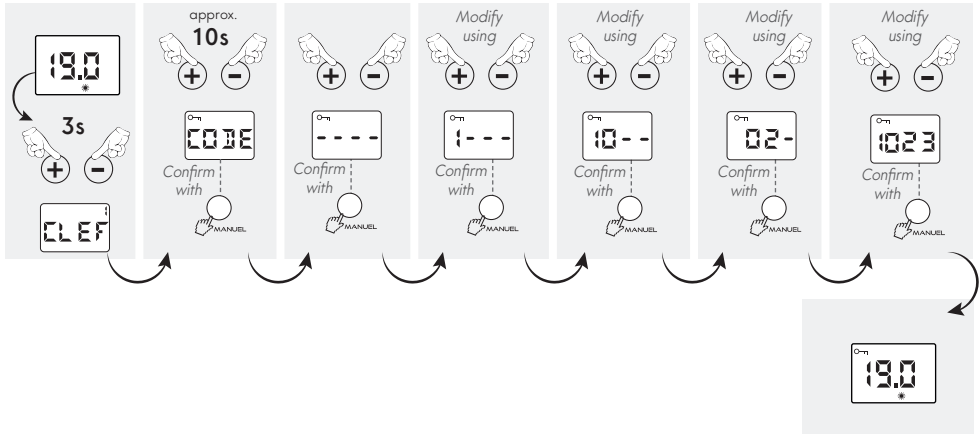

#### NOTE

This function enables you to block access to device settings to prevent any inopportune modification. The heating On/Off key remains active, even when the parental lock is enabled.

### SEQUENCE FOR UNLOCKING WITH YOUR PERSONAL CODE

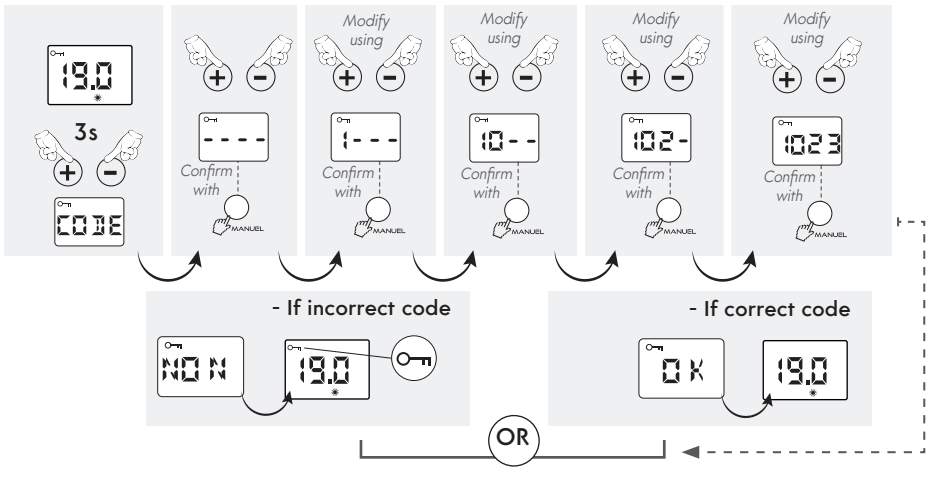



## 5.10 CONSUMPTION SCALE

### INFORMATION

This indicator provides information about the effect of your settings on your consumption.

Indicator

**Green** = Economical

**Red** = Less economical

### DISPLAY

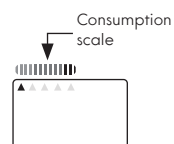

### NOTE

For economical operation, it is recommended not to exceed a temperature of 19°C on average over the entire dwelling.

## 5.11 SETTING OF AUXILIARY FUNCTIONS

### PRESS

### ACTIONS

### DISPLAY



First, the device must be turned off.



**Simultaneously press** and hold for 3 seconds. The screen displays:



**Hold for 3 seconds** to see the first setting screen:



Screen backlighting.

### SETTINGS SCREEN 1

#### BACKLIGHTING TIME SELECTION



Select one of these screen options.

| = 10 seconds

○ = permanent



Allows you to switch to the next settings screen.



## 5.11 SETTING OF AUXILIARY FUNCTIONS (CONTINUED)

PRESS

ACTIONS

DISPLAY

### SETTINGS SCREEN 2

ENABLE / DISABLE THE BUZZER



Select one of these buzzer options.

| = Enabled

○ = Disabled

#### NOTE

The buzzer remains active for the heating On/Off key.



Allows you to switch to the next settings screen.



### SETTINGS SCREEN 3

CELSIUS / FAHRENHEIT SELECTION



Select one of these options.

°C = Celsius

°F = Fahrenheit



Allows you to switch to the next settings screen.



### SETTINGS SCREEN 4

ENABLE / DISABLE THE FRAMING



Framing the Comfort temperature minimizes the increase or lowering of the temperature by + or - 2°C.

These keys enable you to select one of the options.

| = Enabled





○ = Disabled



Return to user mode.



## 5.12 DETAILS OF THE 6 ORDERS GIVEN VIA THE PILOT WIRE



ORDERS	ACTION	DISPLAY
Heating Off	Heating is instantly turned off.	
Eco	Lowering of the temperature by 3.5°C relative to the Comfort position or at your choice.	
Comfort-1	Lowering of the temperature by 1°C relative to the Comfort position.	
Comfort-2	Lowering of the temperature by 2°C relative to the Comfort position.	
Frost Protection	Maintains the room temperature at around 7°C.	

### NOTE

In manual mode, the Frost Protection and Heating Off commands sent by the central programming unit receive priority. To let you know, the "AUTO" symbol flashes.

## 5.13 INTERNAL PROGRAMMING

### TIME DISPLAY

PRESS	ACTIONS	DISPLAY
	Briefly and simultaneously press to display the current time.	

## 5.13 INTERNAL PROGRAMMING (CONTINUED)

### A- SETTING THE TIME

#### PRESS

#### ACTIONS

#### DISPLAY

#### NOTE

In all cases, in order to use the programming, you must set the time and day on your device (factory setting 00:00).



In the event of a power outage lasting more than 30 minutes, you will also need to reset the time on your device.



Simultaneously press for 3 seconds to access the programming menu.



Select one of these options.  
**ON** = Continue  
**OFF** = Exit the setting

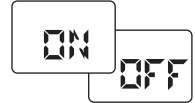

Confirms the previous selection and moves to the next step. The screen displays:



Use these keys to select "Hr" from the drop-down menu whose order is as follows:



PR » **HR** » P4 » P5 » P6 » Exit



Confirms the previous selection and moves to the next step. Set the hour.



Modify the hour using these keys.



Confirms the hours and moves to the next step. Set the minutes.



Modify the minutes using these keys.



Confirms the minutes and moves to the next step. Set the day.





### 5.13 INTERNAL PROGRAMMING (CONTINUED)

#### B - SETTING THE DAY

PRESS	ACTIONS	DISPLAY
-------	---------	---------

#### NOTE

Start with the previous section A - SETTING THE TIME to access the programming menu.



**Select** the desired day using these keys.



JO: LU = Monday  
 JO: MA = Tuesday  
 JO: ME = Wednesday  
 JO: JE = Thursday  
 JO: VE = Friday  
 DY: SA = Saturday  
 JO: DI = Sunday



Confirms the selection of the day and returns to the "PR" drop-down menu.



Use these keys to select "EXIT" from the drop-down menu whose order is as follows:

PR » HR » P4 » P5 » P6 » **Exit**



Confirms the selection of "EXIT" and exits the menu.

## 5.13 INTERNAL PROGRAMMING (CONTINUED)

### PROGRAMMING SET UP









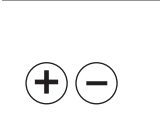

PRESS

ACTIONS

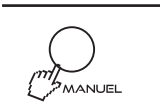
DISPLAY

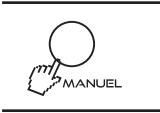
#### NOTE

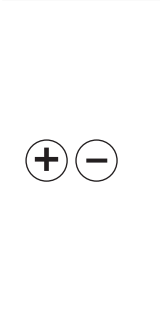
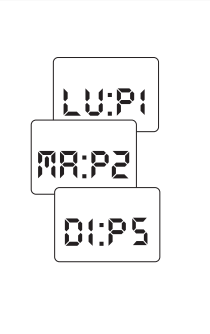
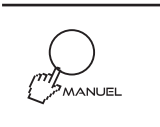
This mode enables the automatic operation of your heater at either the COMFORT set point or the ECO set point.

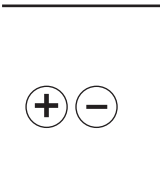
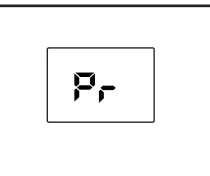
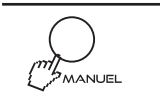
	<p><b>Simultaneously press for 3 seconds</b> to access the programming menu.</p>	
	<p>Select one of these options.  <b>ON</b> = Continue  <b>OFF</b> = Exit the setting</p>	
	<p>Confirms the selection of <b>"ON"</b> and moves to the next step. The screen displays:</p>	
	<p>Confirms the selection of <b>"PR"</b> and moves to the next step. The screen displays:</p>	
	<p>Use these keys to select a program from P1 to P6 (next page) and assign it to a day.            LU = Monday            MA = Tuesday            ME = Wednesday            JE = Thursday            VE = Friday            SA = Saturday            DI = Sunday</p>	
	<p>Confirms the selection of the day and program. Return to the <b>"PR"</b> drop-down menu.</p>	
	<p>Use these keys to select <b>"EXIT"</b> from the drop-down menu whose order is as follows:            PR » HR » P4 » P5 » P6 » <b>Exit</b></p>	
	<p>Confirms the selection of <b>"EXIT"</b> and exits the menu.</p>	



## 5.13 INTERNAL PROGRAMMING (CONTINUED)

### PROGRAMMING SET UP

#### PREDEFINED PROGRAMS (P1 / P2 / P3)

PREDEFINED PROG.	CHOICE	MEANING
	P1	The P1 program enables you to use the <b>Comfort</b> set point temperature from 5 to 9 a.m. in the morning and from 5 to 11 p.m. in the evening.
	P2	The P2 program enables you to use the <b>Comfort</b> set point temperature from from 5 to 9 a.m. in the morning, from noon to 2 p.m. at midday and from 5 to 11 p.m. in the evening.
	P3	The P3 program enables you to use the <b>Comfort</b> set point temperature from 5 a.m. to 11 p.m. in the evening.
USER-DEFINED PROGRAMS (P4 / P5 / P6)		
Method to customize your programs. See the following page.	P4 P5 P6	They allow you to customize up to 3 <b>Comfort</b> set point temperature time ranges to meet your needs.



## 5.13 INTERNAL PROGRAMMING (CONTINUED)

### PROGRAMMING SET UP







PRESS

ACTIONS

DISPLAY

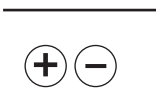
#### NOTE

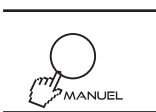
This mode enables the automatic operation of your heater at either the COMFORT set point or the ECO set point.

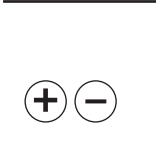
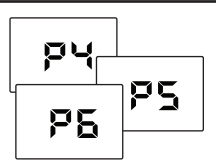
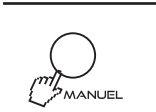
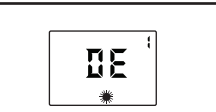
	<p><b>Simultaneously press for 3 seconds</b> to access the programming menu.</p>	
	<p>Select one of these options. <b>ON</b> = Continue <b>OFF</b> = Exit the setting</p>	
	<p>Confirms the selection of <b>"ON"</b> and moves to the next step. The screen displays:</p>	
	<p>Use these keys to select <b>"P4, P5 or P6"</b> from the drop-down menu, whose order is the following: PR » HR » <b>P4 » P5 » P6</b> » Exit</p>	
	<p>Confirms the user-defined program selection and moves to the next step.</p>	

↑  
Accessing  
"P4, P5 or P6"

↓

↑  
**Example of "P4" programming**  
You want to set the **COMFORT** set point temperature for 3 different time ranges:

**mornings from 6 a.m. to 9 a.m.,**  
midday from 11 a.m. to 2 p.m.  
and evenings from 6 p.m. to 10 p.m.

### SEQUENCE OF ACTIONS

### RESULT

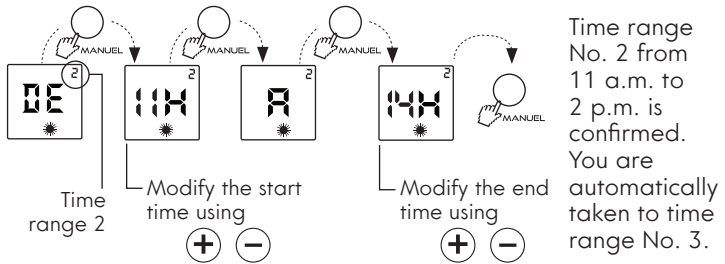
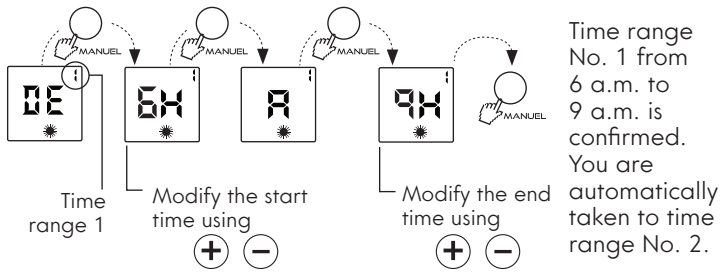

↓



↑  
**Example of  
 "P4" programming**

You want to set the **COMFORT** set point temperature for 3 different time ranges:

mornings from 6 a.m. to 9 a.m., midday from 11 a.m. to 2 p.m. and **evenings from 6 p.m. to 10 p.m.**



### 5.13 INTERNAL PROGRAMMING (CONTINUED)

#### PROGRAMMING SET UP

##### SEQUENCE OF ACTIONS

##### RESULT

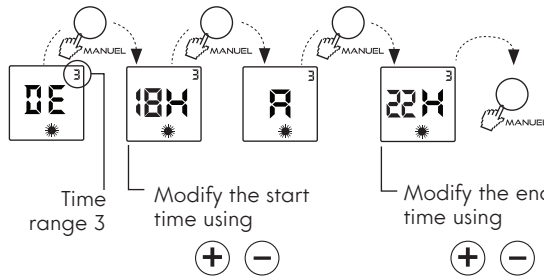

Time range No. 3 from 6 p.m. to 10 p.m. is confirmed. You will return to the initial Pr position.

#### NOTE

Program P5 or P6, or select Exit to exit (see below).

##### PRESS

##### ACTIONS

##### DISPLAY



Use these keys to select "EXIT" from the drop-down menu whose order is as follows:



PR » HR » P4 » P5 » P6 » **Exit**

#### NOTE

If you want, you can return to automatic operation using the pilot wire. Place in the OFF position (see Chapter 5.7).

# 6. DIAGNOSTIC ASSISTANCE

## SOLVING MINOR PROBLEMS

### HARMONIZATION OF DISPLAYS (THERMOSTAT / THERMOMETER)

#### NOTE

This operation is optional.

There may be a difference between the readings displayed on the device and on your thermometer. It is possible to harmonize both displays.

#### Procedure:

- This setting can only be performed if your device is set between 17 and 23°C.
- All doors and windows must be closed.
- Wait for the temperature in the room to stabilize (at least 6 hr), and avoid going in and out of the room as much as possible.
- The control thermometer should be placed in the middle of the room at 1,20 m (3' 11") from the floor. Do not place it on furniture.

#### PRESS

#### ACTIONS

First, make sure that the thermostat is in COMFORT mode.



Press for **3 seconds**.  
You may encounter these two scenarios.

#### A. The set point temperature flashes.

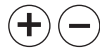

**Harmonization is possible.**  
Use these keys to adjust the temperature.



Confirms the previous step.  
Exits the adjustment mode and returns to normal mode.

#### EXAMPLE

Your thermometer shows 20.5°C and your thermostat 19°C. You can correct by +1.5°C using the "+" key and confirming with the "MANUAL" key.

#### B. The display indicates "NONS".





**Harmonization is not possible.**  
You must wait until the temperature stabilizes.

#### NOTE

If you do not perform an action on the "+" and "-" keys within 15 seconds, the display will return to its initial position.

# 7. DIAGNOSTIC ASSISTANCE

## SOLVING MINOR PROBLEMS

THE DEVICE IS NOT HEATING.		
VERIFICATON	PRESS	ACTION
Make sure the digital screen is active.		Power up the device.
		Successively press to reach the comfort position.
If the digital screen has still not turned on.		Make sure the installation circuit breakers are pushed in and press to power up.
Make sure you are in Comfort mode.		Successively press to reach the comfort position.
Make sure the Open window function is not enabled and that no window or door in the room is open.		Close the door and/or window.
		Press and hold until open window icon disappears to disable this function.
The digital screen is active, but the heating indicator is off.		Check the set point value.
		The temperature of the room does not require heating.
		The device is in Eco mode.
THE DEVICE IS ALWAYS HEATING.		
Check that the temperature setting has not been modified.		Reset the temperature.
Check that the device is not located near an open door and/or in a draft.		Close the door or prevent the draft.
THE DEVICE IS NOT FOLLOWING THE PROGRAMMING COMMANDS.		
Check that it is in programming mode.		Place in programming mode.
Check the programming.		Perform the programming.
Check the time on the device.		Program the time correctly.
IN ALL OTHER CASES, CONTACT A QUALIFIED PERSON.		

# 8. ADDITIONAL INFORMATION

## 8.1 AUTOMATIC THERMAL SAFETY

This device is equipped with an automatic thermal safety feature. During abnormal operation (for example, blocked air inlet or outlet), the device automatically stops.

Once the abnormal operation is corrected, and as soon as the device has cooled sufficiently, it will automatically restart.

### NOTE

If the problem persists, contact your installer.

## 8.2 MAINTENANCE

To keep the device clean, CONVECTAIR recommends performing regular maintenance. To remove dust, use a soft cloth. To remove a stain, dampen the cloth.

For enhanced performance and maximum efficiency of the device, it is recommended to remove dust regularly (once every two weeks) by vacuuming the air inlets and outlets.

***NEVER USE ABRASIVE OR ACETONE-BASED PRODUCTS, WHICH COULD DAMAGE THE COATING OF THE DEVICE.***

***ALL WORK PERFORMED ON OUR DEVICES MUST BE DONE WITH THE POWER OFF AND BY QUALIFIED AND CERTIFIED PERSONNEL. FAILURE TO DO SO MAY INVALIDATE YOUR WARRANTY.***

## 8.3 RECOMMENDATIONS AND ADVICE

Your CONVECTAIR device becomes hot when in use. Particular care must be taken in order to educate young children.

Do not insert objects in the grids, as this may cause short circuits, fires or damage to devices.

Any other use not recommended by CONVECTAIR may cause short circuits, fires or injury to users.

Under special conditions, the heat diffusion grid may turn yellow after some time. This phenomenon is not due to a manufacturing defect. Rather, it is caused by the ambient air, which contains smoke or suspended particles that are heated and then discharged through the grid. This phenomenon is particularly noticeable on "white" devices and can cause severe discoloration.

**Prevention:** It is recommended to clean the grids frequently, especially for appliances installed in areas exposed to cigarette smoke, in the kitchen, the bathroom or in rooms heated with a wood-burning stove. CONVECTAIR devices must never be used during construction work or other activities which generate large amounts of dust.

When starting up the CONVECTAIR device for the first time, it may emit light smoke caused by the heating of particles resulting from the production. This phenomenon is completely normal and will disappear automatically after 2 or 3 minutes of operation.

## 8.4 IDENTIFICATION OF YOUR DEVICE

### IMPORTANT THE CHARACTERISTICS OF THE DEVICE ARE INDICATED ON THE NAMEPLATE.

The nameplate is placed at the back, on the bottom right (control side) of your device, and is used for identification purposes.

It consists of:

- The complete reference number of the device (A), to be specified in case of repair.
- The wattage, voltage and frequency of the device (B).
- The certification laboratory markings (C).
- The week and year of manufacture (D).

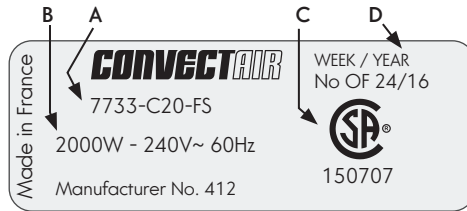

## 8.5 WARRANTY

### 2 YEARS against defects / 5 YEARS for the heating element.

All CONVECTAIR devices carry a double warranty: a two-year warranty against defects in materials and workmanship on all parts, and a five-year warranty on the heating element itself.

Both are applicable from the date of purchase by the consumer and under their specific conditions. Full details are provided with each device. Please keep your purchase and/or installation invoice.

### SERVICE CENTERS:

To find the nearest service center, visit our website ([www.convectair.ca](http://www.convectair.ca)) or contact **CONVECTAIR** customer service at the following number: **1-800-463-6478**.

# CONVECTAIR

1-800-463-6478 | [support@convectair.ca](mailto:support@convectair.ca) | [www.convectair.ca](http://www.convectair.ca)

 A BRAND OF GLEN DIMPLEX AMERICAS